



**BONNET - SEAL
FLARE**



Code	No	Grand. / Size
741-006	3GF-8	1/2

**NOIX RÉDUCTRICE - REDUCING NUT
TUBE X FEM. FLARE**



Code	No	Tube	B
741-027	14FS-4-6	1/4	3/8
741-023	14FS-5-4	1/4	5/16

**NOIX FORGÉE - FORGED NUT
TUBE X FEM. FLARE**

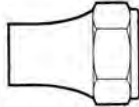

Code	No	Tube	B
741-014	14FL-6	3/8	3/8
741-016	14FL-8	1/2	1/2

**RACCORD À PIVOT
SWIVEL NUT CONNECTOR
FEM. FLARE**

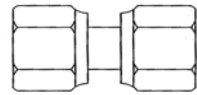

Code	No	A	B
741-025	14FSV-6	3/8	3/8
741-042	14FSV-8	1/2	1/2
741-044	14FSV-10	5/8	5/8

**NOIX FORGÉE - FORGED NUT
TUBE X FEM. FLARE**

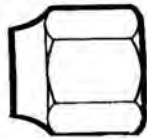

Code	No	Tube	B
741-022	14FS-4	1/4	1/4
741-026	14FS-6 (CH)	3/8	3/8
741-037	14FS-6 (US)	3/8	3/8
741-028	14FS-8	1/2	1/2
741-030	14FS-10	5/8	5/8
741-032	14FS-12	3/4	3/4

**NOIX LONGUE - LONG NUT
TUBE X FEM. FLARE**

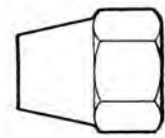

Code	No	Tube	B
741-050	41FL-4	1/4	1/4
741-052	41FL-6	3/8	3/8
741-054	41FL-8	1/2	1/2

**NOIX MOYENNE - MEDIUM NUT
TUBE X FEM. FLARE**

A B

Code	No	A & B
741-059	41FS-3	3/16
741-060	41FS-4	1/4
741-062	41FS-5	5/16
741-064	41FS-6	3/8
741-066	41FS-8	1/2
741-068	41FS-10	5/8
741-070	41FS-12	3/4

**UNION
MALE FLARE**

A B

Code	No	A & B
741-076	42-4	1/4
741-078	42.5	5/16
741-080	42-6	3/8
741-082	42-8	1/2
741-084	42-10	5/8
741-086	42-12	3/4

**NOIX MOYENNE - MEDIUM NUT
TUBE X FEM. FLARE**

A B

Code	No	A	B
741-065	41FS-6-4	3/8	1/4
741-067	41FS-8-6	1/2	3/8

RÉDUCTEUR - REDUCER

A B

Code	No	A	B
741-092	42-5-4	5/16	1/4
741-094	42-6-4	3/8	1/4
741-098	42-8-4	1/2	1/4
741-099	42-8-5	1/2	5/16
741-100	42-8-6	1/2	3/8
741-102	42-10-6	5/8	3/8
741-104	42-10-8	5/8	1/2

**RÉDUCTEUR - REDUCER
MALE FLARE X FEM. FLARE**

A B

Code	No	A	B
741-045	35-4-6	1/4	3/8
741-048	35-6-8	3/8	1/2
741-049	35-8-6	1/2	3/8

**CONNECTEUR - CONNECTOR
MALE FLARE X FPT**

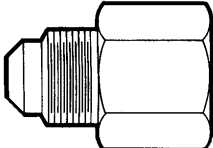

Code	No	A	B
741-111	46-2-2	1/8	1/8
741-112	46-3-2	3/16	1/8
741-114	46-4-2	1/4	1/8
741-116	46-4-4	1/4	1/4
741-118	46-4-6	1/4	3/8
741-119	46-4-8	1/4	1/2
741-120	46-5-2	5/16	1/8
741-122	46-5-4	5/16	1/4
741-124	46-6-2	3/8	1/8
741-126	46-6-4	3/8	1/4
741-128	46-6-6	3/8	3/8
741-130	46-6-8	3/8	1/2
741-132	46-6-12	3/8	3/4
741-134	46-8-4	1/2	1/4
741-136	46-8-6	1/2	3/8
741-138	46-8-8	1/2	1/2
741-140	46-8-12	1/2	3/4
741-142	46-10-6	5/8	3/8
741-144	46-10-8	5/8	1/2
741-146	46-10-12	5/8	3/4
741-147	46-12-12	3/4	3/4

**CONNECTEUR - CONNECTOR
MALE FLARE x MALE PIPE**

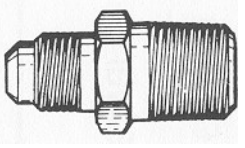

Code	No	A	B
741-152	48-4-2	1/4	1/8
741-154	48-4-4	1/4	1/4
741-156	48-4-6	1/4	3/8
741-158	48-4-8	1/4	1/2
741-159	48-5-6	5/16	3/8
741-162	48-6-2	3/8	1/8
741-164	48-6-4	3/8	1/4
741-166	48-6-6	3/8	3/8
741-168	48-6-8	3/8	1/2
741-170	48-6-12	3/8	3/4
741-172	48-8-4	1/2	1/4
741-174	48-8-6	1/2	3/8
741-176	48-8-8	1/2	1/2
741-178	48-8-12	1/2	3/4
741-182	48-10-6	5/8	3/8
741-184	48-10-8	5/8	1/2
741-186	48-10-12	5/8	3/4
741-190	48-12-8	3/4	1/2
741-191	48-12-12	3/4	3/4

**BOYAU À MALE PIPE
HOSE BARB TO MALE PIPE**

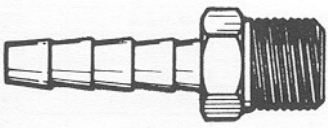

Code	No	A	B
741-200	125-4-2	1/4	1/8
741-192	125-4-4	1/4	1/4
741-204	125-4-6	1/4	3/8
741-206	125-6-4	3/8	1/4
741-208	125-6-6	3/8	3/8
741-209	125-6-8	3/8	1/2
741-212	125-8-6	1/2	3/8
741-214	125-8-8	1/2	1/2

**BOYAU À FEMELLE PIPE
HOSE BARB TO FEMALE PIPE**

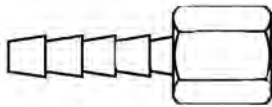

Code	No	A	B
741-222	126-4-2	1/4	1/8
741-224	126-4-4	1/4	1/4
741-226	126-4-6	1/4	3/8
741-228	126-6-4	3/8	1/4
741-230	126-6-6	3/8	3/8
741-232	126-6-8	3/8	1/2
741-234	126-8-8	1/2	1/2

**BOYAU À NOIX FLARE TOURNANTE
HOSE TO SWIVEL FEMALE FLARE**



Code	No	A	B
741-247	128-4-4	1/4	1/4
741-248	128-4-6	1/4	3/8
741-254	128-6-6	3/8	3/8
741-257	128-6-8	3/8	1/2

**BOYAU À MALE FLARE
HOSE BARB TO MALE FLARE**

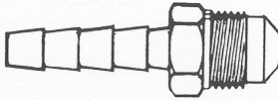

Code	No	A	B
741-240	127-4-6	1/4	3/8
741-242	127-6-6	3/8	3/8
741-243	127-6-8	3/8	1/2
741-244	127-8-8	1/2	1/2

**BOYAU À MALE FLARE INVERSÉ
HOSE TO MALE INVERTED FLARE**

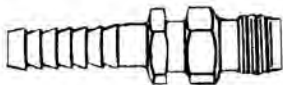

Code	No	A	B
741-201	121-4-4	1/4	1/4
741-202	121-6-4	3/8	1/4

BOYAU À NOIX TOURNANTE 9/16 GAUCHE
HOSE TO SWIVEL NUT 9/16 LH

Code	No	A	B
741-266	133-3L	3/16	9/16 LH
741-270	133-4L	1/4	9/16 LH
741-274	133-6L	3/8	9/16 LH

CONNECTEUR - CONNECTOR
GAUCHE 9/16 LH x MPT

Code	No	A	B
741-282	135-LB	9/16 LH	1/4 MPT
741-283	135-LC	9/16 LH	3/8 MPT

UNION
GAUCHE 9/16 LH

Code	No	A & B
741-286	136-L	9/16 LH

CONNECTEUR - CONNECTOR
DROIT 9/16 RH x MPT

Code	No	A	B
741-284	135-R	9/16 RH	1/4 MPT

UNION
DROIT 9/16 RH

Code	No	A & B
741-288	136-R	9/16 RH

UNION "T" COMBINÉE MALE
FLARE MALE TEE COMBINATION

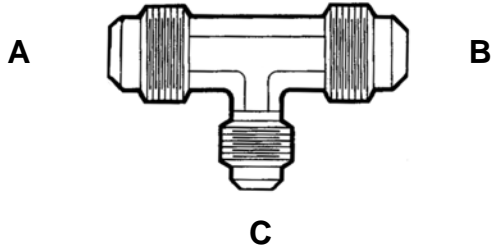

Code	No	A	B	C
741-314	144-4-4-6	1/4	1/4	3/8
741-316	144-6-6-4	3/8	3/8	1/4
741-318	144-6-6-8	3/8	3/8	1/2
741-320	144-6-6-10	3/8	3/8	5/8
741-322	144-6-8-8	3/8	1/2	1/2
741-324	144-6-8-10	3/8	1/2	5/8
741-326	144-6-10-10	3/8	5/8	5/8
741-327	144-8-6-6	1/2	3/8	3/8
741-328	144-8-8-4	1/2	1/2	1/4
741-330	144-8-8-6	1/2	1/2	3/8
741-332	144-8-8-10	1/2	1/2	5/8
741-334	144-8-10-10	1/2	5/8	5/8
741-335	144-10-6-6	5/8	3/8	3/8
741-336	144-10-8-8	5/8	1/2	1/2
741-338	144-10-10-6	5/8	5/8	3/8
741-340	144-10-10-8	5/8	5/8	1/2

UNION "T" UNION
MALE FLARE

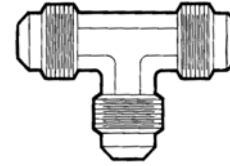

Code	No	Dim.
741-298	144-4	1/4
741-300	144-5	5/16
741-302	144-6	3/8
741-304	144-8	1/2
741-306	144-10	5/8
741-308	144-12	3/4

"T" MALE À PIPE
TEE MALE TO PIPE

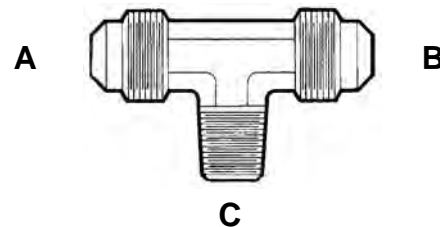

Code	No	A & B	C
741-346	145-4-2	1/4	1/8
741-348	145-4-4	1/4	1/4
741-352	145-6-2	3/8	1/8
741-354	145-6-4	3/8	1/4
741-356	145-6-6	3/8	3/8
741-358	145-6-8	3/8	1/2
741-359	145-8-4	1/2	1/4
741-360	145-8-8	1/2	1/2
741-361	145-8-6	1/2	3/8
741-368	145-10-6	5/8	3/8
741-370	145-10-8	5/8	1/2

CROIX - CROSS

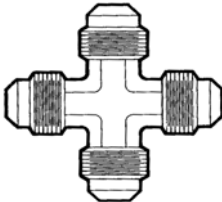

Code	No	Dim.
741-376	147-4	1/4
741-378	147-6	3/8
741-380	147-8	1/2
741-382	147-10	5/8

**CONNECTEUR - CONNECTOR FLARE
FEM. FLARE INV. X MALE PIPE**

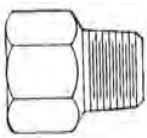

Code	No	A	B
741-379	148-4-2	1/4	1/8
741-383	148-4-4	1/4	1/4
741-381	148-6-4	3/8	1/4
741-384	148-6-6	3/8	3/8
741-385	148-6-8	3/8	1/2
741-386	148-8-6	1/2	3/8

**BOUCHON - PLUG
MALE FLARE INVERSÉ
MALE PLUG INVERTED FLARE**

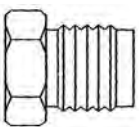

Code	No	A & B
741-387	148-4	1/4

**COUDE MALE - MALE ELBOW
MALE FLARE X MALE PIPE**

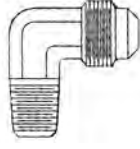

Code	No	A	B
741-388	149-2-2	1/8	1/8
741-390	149-4-2	1/4	1/8
741-392	149-4-4	1/4	1/4
741-394	149-4-6	1/4	3/8
741-396	149-5-2	5/16	1/8
741-400	149-6-2	3/8	1/8
741-402	149-6-4	3/8	1/4
741-404	149-6-6	3/8	3/8
741-406	149-6-8	3/8	1/2
741-408	149-6-12	3/8	3/4
741-410	149-8-4	1/2	1/4
741-412	149-8-6	1/2	3/8
741-414	149-8-8	1/2	1/2
741-416	149-8-12	1/2	3/4
741-418	149-10-4	5/8	1/4
741-420	149-10-6	5/8	3/8
741-422	149-10-8	5/8	1/2
741-424	149-10-12	5/8	3/4
741-425	149-12-12	3/4	3/4

**CONNECTEUR - CONNECTOR FLARE
FEM. FLARE X MALE PIPE**

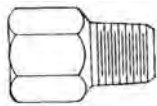

Code	No	A	B
741-734	148-4-2	1/4	1/8

**COUDE FEMELLE - FEMALE ELBOW
MALE FLARE X FEM. PIPE**

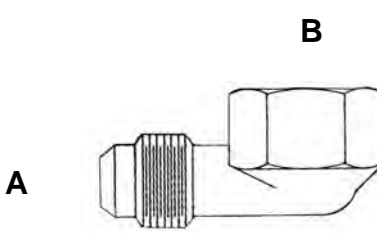

Code	No	A	B
741-430	150-4-2	1/4	1/8
741-432	150-4-4	1/4	1/4
741-434	150-5-2	5/16	1/8
741-436	150-5-4	5/16	1/4
741-438	150-6-2	3/8	1/8
741-440	150-6-4	3/8	1/4
741-442	150-6-6	3/8	3/8
741-444	150-6-8	3/8	1/2
741-446	150-6-12	3/8	3/4
741-448	150-8-4	1/2	1/4
741-450	150-8-6	1/2	3/8
741-452	150-8-8	1/2	1/2
741-454	150-8-12	1/2	3/4
741-456	150-10-6	5/8	3/8
741-458	150-10-8	5/8	1/2
741-460	150-10-12	5/8	3/4

**"T" MALE - MALE TEE
FLARE X PIPE**

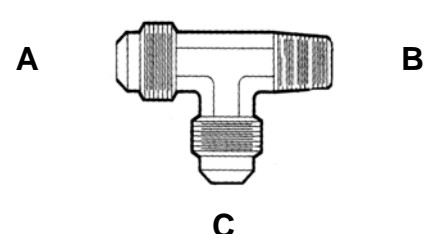

Code	No	A & C	B
741-465	151-4-2	1/4	1/8
741-466	151-4-4	1/4	1/4
741-468	151-5-2	5/16	1/8
741-470	151-5-4	5/16	1/4
741-472	151-6-2	3/8	1/8
741-474	151-6-4	3/8	1/4
741-476	151-6-6	3/8	3/8
741-477	151-6-8	3/8	1/2
741-478	151-8-4	1/2	1/4
741-480	151-8-6	1/2	3/8
741-482	151-8-8	1/2	1/2
741-484	151-10-6	5/8	3/8
741-486	151-10-8	5/8	1/2

**COUDE PIVOT - SWIVEL ELBOW
MALE FLARE X FEM. FLARE**

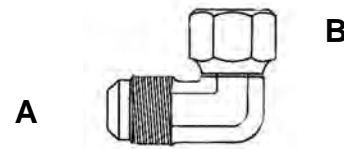

Code	No	A	B
741-490	153-6-6	3/8	3/8

TEE MALE FLARE X FEM. PIPE

Code	No	A	B
741-492	154-6-6	3/8	3/8
741-493	154-6-8	3/8	1/2
741-494	154-8-8	1/2	1/2

**COUDE RÉDUCTEUR
REDUCER ELBOW**

Code	No	A	B
741-518	155-6-4	3/8	1/4
741-520	155-8-6	1/2	3/8
741-522	155-10-6	5/8	3/8
741-523	155-10-8	5/8	1/2
741-524	155-12-8	3/4	1/2

**COUDE "UNION" ELBOW
FLARE X FLARE**

Code	No	A & B
741-501	155-3	3/16
741-500	155-4	1/4
741-502	155-5	5/16
741-504	155-6	3/8
741-506	155-8	1/2
741-508	155-10	5/8
741-510	155-12	3/4

**ADAPTATEUR EN CROIX
CROSS ADAPTOR
MALE FLARE X FEM. PIPE**

Code	No	A	B
741-530	157-6-6	3/8	3/8
741-531	157-6-8	3/8	1/2
741-532	157-8-8	1/2	1/2

**ADAPTATEUR - ADAPTOR
MALE FLARE X FEM. PIPE**

Code	No	A	B
741-537	158-6-6	3/8	3/8
741-538	158-6-8	3/8	1/2

**COUDE 45° ELBOW
MALE FLARE X MALE PIPE**

Code	No	A	B
741-544	159-4-2	1/4	1/8
741-546	159-4-4	1/4	1/4
741-547	159-5-4	5/16	1/4
741-548	159-6-4	3/8	1/4
741-550	159-6-6	3/8	3/8
741-551	159-8-6	1/2	3/8
741-552	159-8-8	1/2	1/2

**BAGUE - BUSHING
MALE PIPE X FEM. PIPE**

Code	No	A	B
741-568	209-4-2	1/4	1/8
741-570	209-6-2	3/8	1/8
741-572	209-6-4	3/8	1/4
741-574	209-8-2	1/2	1/8
741-576	209-8-4	1/2	1/4
741-578	209-8-6	1/2	3/8
741-580	209-12-2	3/4	1/8
741-582	209-12-4	3/4	1/4
741-584	209-12-6	3/4	3/8
741-586	209-12-8	3/4	1/2

**UNION
FEM. X FEM PIPE**

Code	No	A	B
741-556	207-2	1/8	1/8
741-557	207-4	1/4	1/4
741-560	207-6	3/8	3/8
741-559	207-8	1/2	1/2

**BOUCHON CARRÉE - SQUARE HEAD PLUG
MALE PIPE**

Code	No	MPT
741-591	211-2	1/8
741-592	211-4	1/4
741-594	211-6	3/8
741-596	211-8	1/2
741-598	211-12	3/4

**UNION 3 PIECES
FEM. X FEM. PIPE**

Code	No	A & B
741-562	208-8	1/2
741-563	208-12	3/4

CAPUCHON FEM. - FEM. PIPE CAP

Code	No	Dim.
741-604	213-4	1/4
741-606	213-6	3/8

**MAMELON COURT - CLOSE NIPPLE
MALE PIPE**

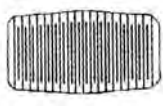
A  B

Code	No	A	B
741-611	215-2	1/8	1/8
741-612	215-4	1/4	1/4
741-614	215-6	3/8	3/8
741-616	215-8	1/2	1/2
741-618	215-12	3/4	3/4

UNION - MALE PIPE

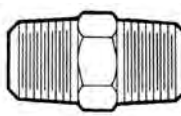
A  B

Code	No	A & B
741-656	216-2	1/8
741-658	216-4	1/4
741-659	216-6	3/8
741-661	216-8	1/2

**MAMELON LONG - LONG NIPPLE
MALE PIPE**

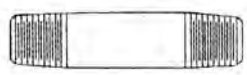
A  B

Code	No	A	B	Long- Length
741-624	215-2-15	1/8	1/8	1-1/2"
741-626	215-4-15	1/4	1/4	1-1/2"
741-628	215-6-15	3/8	3/8	1-1/2"
741-627	215-8-15	1/2	1/2	1-1/2"
741-636	215-2-20	1/8	1/8	2"
741-638	215-4-20	1/4	1/4	2"
741-639	215-6-20	3/8	3/8	2"
741-640	215-8-20	1/2	1/2	2"
741-643	215-2-25	1/8	1/8	2-1/2"
741-644	215-4-25	1/4	1/4	2-1/2"
741-645	215-4-30	1/4	1/4	3"

**UNION RÉDUCTEUR - REDUCER UNION
MALE PIPE X MALE PIPE**

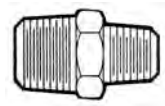
A  B

Code	No	A	B
741-664	216-6-4	3/8	1/4
741-666	216-8-6	1/2	3/8

**BOUCHON HEXAGONE - HEX-HEAD PLUG
MALE PIPE**

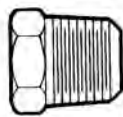
 A

Code	No	A
741-670	218-2	1/8
741-669	218-4	1/4
741-671	218-6	3/8
741-672	218-8	1/2

**ADAPTATEUR - ADAPTOR
FEM. PIPE X MALE PIPE**

Code	No	A	B
741-676	222-2-2	1/8	1/8
741-678	222-4-2	1/4	1/8
741-680	222-4-4	1/4	1/4
741-682	222-6-4	3/8	1/4
741-684	222-6-6	3/8	3/8
741-686	222-8-6	1/2	3/8
741-677	222-8-8	1/2	1/2
741-683	222-12-8	3/4	1/2

UNION

Code	No	A & B
741-690	314-3	3/16
741-692	314-4	1/4
741-693	314-5	5/16
741-694	314-6	3/8
741-696	314-8	1/2

UNION "T" UNION

Code	No	A - B - C
741-687	224-4	1/4
741-685	224-6	3/8

**BOUCHON - PLUG
MALE FLARE**

Code	No	Grand. / Size
741-704	639-4	1/4
741-706	639-5	5/16
741-708	639-6	3/8
741-710	639-8	1/2
741-712	639-10	5/8

**BOUCHON - PLUG
MALE PIPE**

Code	No	Dim.
701-099	G-30	3/8 MPT

**CAPUCHON - CAP
FEM. FLARE**

Code	No	Grand. / Size
741-716	640-4	1/4
741-718	640-5	5/16
741-711	640-6	3/8
741-722	640-8	1/2
741-724	640-10	5/8
741-725	640-12	3/4

CLAPET "T" CHECK

Code	No	A & B	C
741-740	2000	1/4 inv.	1/4 MPT

**COUDE - ELBOW
MALE PIPE**

Code	No	A & B
741-296	116-4	1/4

"TEE" BLOCK

Code	No	
741-744	2001S	POL x POL
741-742	2001	Clapet/ <i>Excess Flow</i>

**COUDE - ELBOW
MALE PIPE X FEM. PIPE**

Code	No	A & B
741-791	2202-2	1/8
741-790	2202-4	1/4
741-792	2202-6	3/8
741-794	2202-8	1/2

**SOUPAPE SÉCURITÉ 440 PSI
440 PSI RELIEF VALVE**

Code	No	
741-701	2000	1/4 MPT

**COUDE UNION - UNION ELBOW
FEM. PIPE**

Code	No	A & B
741-786	2200-2	1/8
741-787	2200-4	1/4
741-788	2200-6	3/8
741-789	2200-8	1/2

"T" FEMELLE - FEMALE TEE

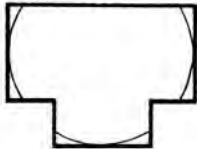

Code	No	Dim.
741-796	2203-4	1/4
741-798	2203-6	3/8
741-800	2203-8	1/2
741-799	2203-12	3/4

**COUDE FLARE INVERSÉ
INVERTED FLARE ELBOW**

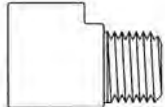

Code	No	INV.	MPT
741-819	2291-2-2	1/8	1/8
741-820	2291-4-2	1/4	1/8
741-822	2291-4-4	1/4	1/4

CROIX - CROSS

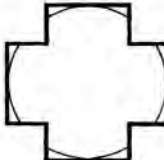

Code	No	Dim.
741-805	2205-2	1/8
741-806	2205-4	1/4
741-808	2205-6	3/8
741-809	2205-8	1/2
741-810	2205-12	3/4

CAPUCHON POL - POL CAP

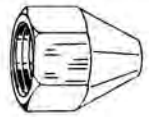

Code	No	
741-756	2004	POL

**CONNECTEUR - COUPLING
MALE FLARE**

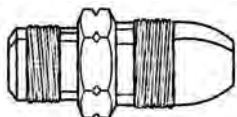

Code	No	Flare
741-760	2005-6	3/8
741-762	2005-8	1/2
741-764	2005-10	5/8

COUDE 45° ELBOW

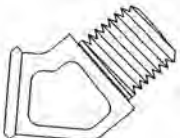

Code	No	FPT	MPT
741-815	2214-4	1/4	1/4
741-816	2214-6	3/8	3/8
741-817	2214-8	1/2	1/2

BOUCHON POL PLUG

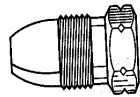

Code	No	
741-776	2010	POL

**CONNECTEUR - COUPLING
FEM. X POL MALE**

FPT  B

Code	No	FPT	B
741-765	2008	1/4	POL

**CONNECTEUR - COUPLING
MALE PIPE X POL FEM.**



Code	No	MPT
741-770	2011-4	1/4
741--771	2011-8	1/2
741-772	2011-12	3/4

CONNECTEUR - COUPLING



Code	No	MPT
741-777	2014-6	3/8

**CONNECTEUR - CONNECTOR
MALE INV. X TUBE**

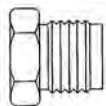
A  B

Code	No	A & B
741-818	2290-6	3/8

ÉCROU POL - POL NUT



Code	No	
741-750	2002B	7/8

POL "O" RING ORIFICE #60

A 

Code	No	A	Orif.
741-739	G1657	1/4	#60

POL "O" RING ORIFICE # 60



Code	No	MPT	Orif.
741-738	G1638	1/4	#60
741-748	G1638 Full Flow	1/4	Full Flow

**ENSEMBLE POL ASSEMBLY
"O" RING**



Code	No	MPT	Orif.
741-757	N2013-60	1/4	#60
741-746	2002	1/4	Full Flow

**ENSEMBLE POL ASSEMBLY
"O" RING**



A

Code	No	A	B
741-758	N2012-60	1/4	POL
741-199	POL BARB 3/8	3/8	POL

**POL GAUCHE - LEFT HAND POL
"O" RING**



9/16

Code	No	MPT
741-782	2020	9/16

**ENSEMBLE POL MANETTE
POL "O" RING HANDWHEEL**



Code	No	MPT	Orif.
741-755	HW2013-60	1/4	#60

**ADAPTATEUR POL X QCC1
POL ADAPTOR X QCC1**



A **B**

Code	No	A	B
250-004	M-1899	QCC	POL
400-004	Sur carton / Skin pack		

**POL À CLAPET - POL EXCESS FLOW
"O" RING**



MPT

Code	No	MPT	POL
741-783	2020	1/4	Exc. Flow

**ADAPTATEUR QCC x 1/4 MPT
QCC ADAPTOR TO 1/4 MPT**



A **B**

Code	No	A	B
250-008	M-1890	QCC	1/4
400-008	Sur carton / Skin pack		

**RACCORD QCC1
QCC1 ADAPTOR**



A **B**

Code	No	A	MPT
250-003	M-1851	QCC	1/4

**Permet de connecter un régulateur
QCC à un réservoir jetable
Allows a QCC regulator to connect
to a disposable cylinder**



A **B**

Code	No	A	B
250-018	AF-50	BOM FEM	QCC
401-018	Sur carton / Skin pack		

BOM FEM. TOURNANT X BOYAU
BOM FEM. SWIVEL TO HOSE



A **B**

Code	No	A	B
250-039	B2039	BOM	1/4
400-039	Sur carton / <i>Skin pack</i>		

BOM MALE TOURNANT X BOYAU
BOM MALE SWIVEL TO HOSE
Clapet - Safety valve



A **B**

Code	No	A	B
250-040	B2040	1/4	BOM
400-040	Sur carton / <i>Skin pack</i>		

ROBINETS DE DRAINAGE
DRAIN COCKS

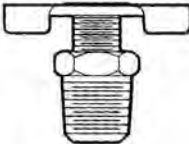

Code	No	Dim.
741-827	DC 606-2	1/8
741-829	DC 606-4	1/4
741-830	DC 606-6	3/8
741-835	DC 606-8	1/2

ADAPTATEUR LIQUIDE
LIQUID ADAPTOR



Code	No		MPT
730-029	M306	POL	1/4

ADAPTATEUR DE REMPLISSAGE
FILLER ADAPTOR



Code	No
250-010	ME2368

MANETTE POL - POL HAND WHEEL



Code	Description
730-008	Manette POL / <i>POL Handwheel</i>

POL - "O" RING



Code	No
780-082	B-110

**ÉCROU TUBE POUR VEILLEUSE
BREAKAWAY FERRULE**



Code	Description	Comp.
722-222	NOIX SLEEVE SLEEVE NUT	1/4

**BAGUE À COMPRESSION
COMPRESSION SLEEVE**

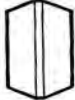

Code	No	Dim.
741-860	60-2	1/8
741-861	60-3	3/16
741-862	60-4	1/4
741-863	60-5	5/16
741-864	60-6	3/8
741-865	60-7	7/16
741-866	60-8	1/2
741-867	60-10	5/8

**BOUCHON À COMPRESSION
COMPRESSION PLUG**

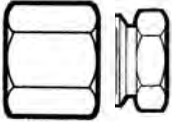

Code	No	Dim.
741-837	67-4	1/4
741-838	67-6	3/8

**NOIX À COMPRESSION
COMPRESSION NUT**

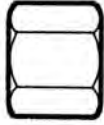
Tube  B

Code	No	Tube	B
741-870	61-2	1/8	1/8
741-871	61-3	3/16	3/16
741-872	61-4	1/4	1/4
741-868	61-5	5/16	5/16
741-873	61-6	3/8	3/8
741-869	61-7	7/16	7/16
741-874	61-8	1/2	1/2
741-875	61-10	5/8	5/8

**TEE UNION
TUBE X TUBE X TUBE**

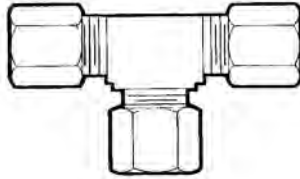

Code	No	Tube
741-927	64-2	1/8
741-928	64-3	3/16
741-929	64-4	1/4
741-930	64-5	5/16
741-937	64-7	3/8
741-939	64-8	7/16
741-931	64-8	1/2

**CONNECTEUR - CONNECTOR
TUBE X MALE PIPE**

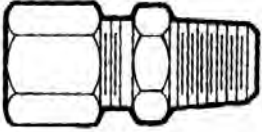
Tube

B

Code	No	Tube	B
741-844	68-2-2	1/8	1/8
741-846	68-3-4	3/16	1/4
741-884	68-4-2	1/4	1/8
741-885	68-4-4	1/4	1/4
741-883	68-4-6	1/4	3/8
741-847	68-4-8	1/4	1/2
741-886	68-5-2	5/16	1/8
741-888	68-5-6	5/16	3/8
741-889	68-6-2	3/8	1/8
741-891	68-6-4	3/8	1/4
741-892	68-6-6	3/8	3/8
741-890	68-6-8	3/8	1/2
741-893	68-7-4	7/16	1/4
741-848	68-8-4	1/2	1/4
741-849	68-8-6	1/2	3/8
741-894	68-8-8	1/2	1/2
741-850	68-8-12	1/2	3/4
741-895	68-10-8	5/8	1/2

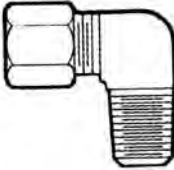
**COUDE - ELBOW
TUBE X MALE PIPE**

Tube

B

Code	No	Tube	B
741-896	69-2-2	1/8	1/8
741-897	69-3-2	3/16	1/8
741-898	69-3-4	3/16	1/4
741-902	69-4-2	1/4	1/8
741-903	69-4-4	1/4	1/4
741-905	69-4-6	1/4	3/8
741-899	69-4-8	1/4	1/2
741-907	69-5-2	5/16	1/8
741-908	69-5-4	5/16	1/4
741-910	69-5-6	5/16	3/8
741-906	69-6-2	3/8	1/8
741-912	69-6-4	3/8	1/4
741-913	69-6-6	3/8	3/8
741-915	69-7-4	7/16	1/4
741-919	69-8-4	1/2	1/4
741-831	69-8-6	1/2	3/8
741-832	69-8-8	1/2	1/2
741-833	69-8-12	1/2	3/4

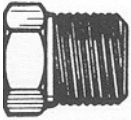
**ADAPTATEUR À COMPRESSION
COMPRESSION ADAPTOR**

Tube

B

Code	No	Tube	Dim.
741-702	411-4	1/4	1/4
741-703	411-7	7/16	1/2

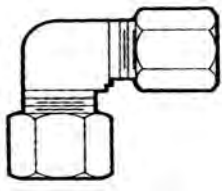
COUDE - ELBOW



Code	No	Tube
741-839	65-2	1/8
741-840	65-3	3/16
741-932	65-4	1/4
741-933	65-5	5/16
741-934	65-6	3/8
741-841	65-7	7/16
741-842	65-8	1/2
741-843	65-10	5/8

**UNION RÉDUCTEUR
REDUCER UNION**

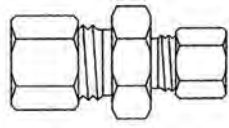

Code	No	A	B
741-878	62-4-3	1/4	3/16
741-852	62-5-4	5/16	1/4
741-853	62-6-4	3/8	1/4
741-881	62-6-5	3/8	5/16
741-854	62-8-6	1/2	3/8

UNION - UNION

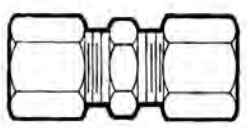

Code	No	Tube
741-880	62-2	1/8
741-876	62-3	3/16
741-877	62-4	1/4
741-879	62-5	5/16
741-882	62-6	3/8
741-857	62-8	1/2
741-858	62-10	5/8

**COLLIERS DE SERRAGE
"O" CLAMPS**



Code	Grandeur Size	Pouces / Inches	
		Fermé Closed	Ouvert Open
780-055	3/16	.118	.197
780-056	1/4	.197	.276
780-057	5/16	.276	.354
780-061	1/2	.433	.512
780-063	9/16	.512	.591
780-065	19/32	.591	.669
780-067	5/8	.591	.708
780-069	3/4	.669	.787
780-070	7/8	.787	.905
780-071	1	.905	1.063
780-074	1-1/8	1.063	1.220
780-073	Pince / Hand pincer		

BOYAU X MALE - HOSE TO MALE

Code Vrac/Bulk	Sur carton Skin pack	Mod.	A	B
740-100	401-100	193-6-12	3/8	3/4
740-101	401-101	193-8-12	1/2	3/4
740-102	401-102	193-10-12	5/8	3/4
740-103	401-103	193-12-12	3/4	3/4
740-104	401-104	193-16-12	1"	3/4

**MALE X ÉCROU TOURNANT
MALE PIPE TO SWIVEL NUT**

Code Vrac/Bulk	Sur carton Skin pack	Mod.	A	B
740-110	401-110	194-4-12	1/4	3/4
740-111	401-111	194-6-12	3/8	3/4

**BOYAU A ÉCROU TOURNANT FEMELLE
HOSE TO SWIVEL FEM. NUT**

Code Vrac/Bulk	Sur carton Skin pack	Mod.	A	B
740-115	401-115	195-6-12	3/8	3/4
740-116	401-116	195-8-12	1/2	3/4
740-117	401-117	195-10-12	5/8	3/4
740-118	401-118	195-12-12	3/4	3/4
740-119	401-119	195-16-12	1"	3/4

ÉCROU POUR BARB - NUT FOR BARB

Code Vrac/Bulk	Sur carton Skin pack	Mod.	Dim.
740-157	401-157	N195-12	3/4

CAPUCHON FEMELLE - FEMALE CAP

Code Vrac/Bulk	Sur carton Skin pack	Mod.	A
740-154	401-154	200-12	3/4

**UNION ÉCROUS TOURNANTES
SWIVEL FEM. UNION**

Code Vrac/Bulk	Sur carton Skin pack	Mod.	A	B
740-160	401-160	203-12-12	3/4	3/4

**ADAPTATEUR FEM. & ÉCROU TOURNANT
FEM. PIPE TO SWIVEL NUT**

Code Vrac/Bulk	Sur carton Skin pack	Mod.	A	B
740-150	401-150	S199-8-12	1/2	3/4
740-151	401-151	S199-12-12	3/4	3/4

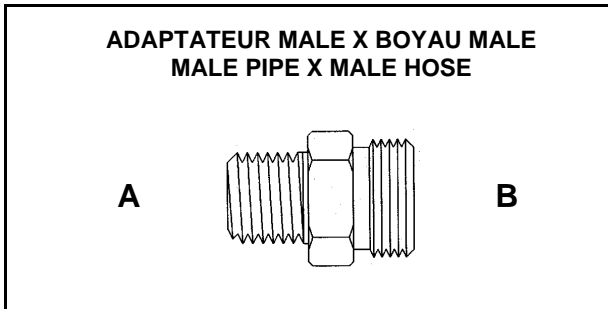

Code Vrac/Bulk	Sur carton Skin pack	Mod.	A	B
740-122	401-122	196-6-12	3/8	3/4
740-123	401-123	196-8-12	1/2	3/4
740-124	401-124	196-12-12	3/4	3/4
740-125	401-125	196-16-12	1"	3/4
740-128	401-128	196-16-16	1"	1"

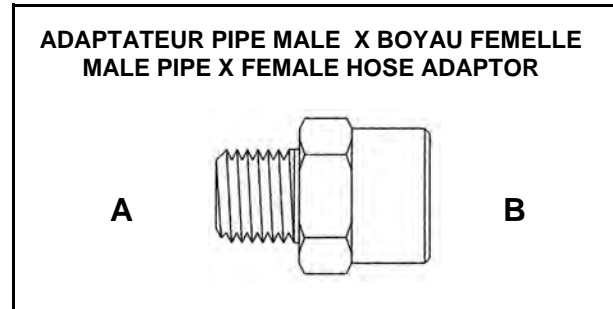

Code Vrac/Bulk	Sur carton Skin pack	Mod.	A	B
740-145	401-145	199-8-12	1/2	3/4
740-146	401-146	199-12-12	3/4	3/4

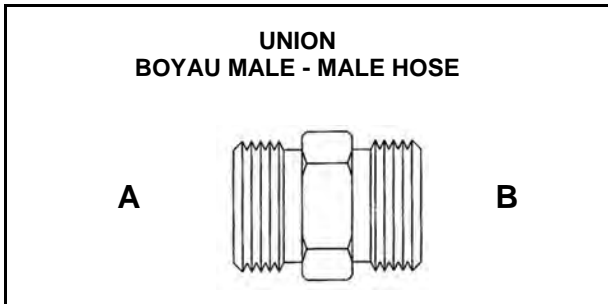

Code Vrac/Bulk	Sur carton Skin pack	Mod.	A
740-129	401-129	U196-12-12	3/4

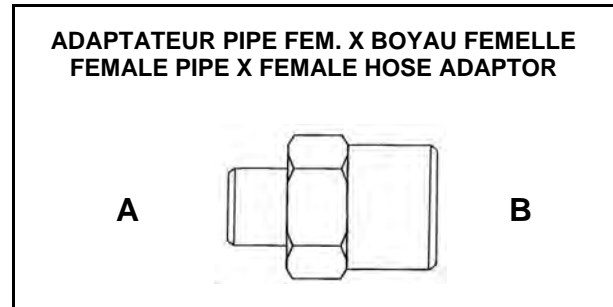

Code Vrac/Bulk	Sur carton Skin pack	Mod.	A	B
740-138	401-138	198-8-12	1/2	3/4
740-139	401-139	198-12-12	3/4	3/4

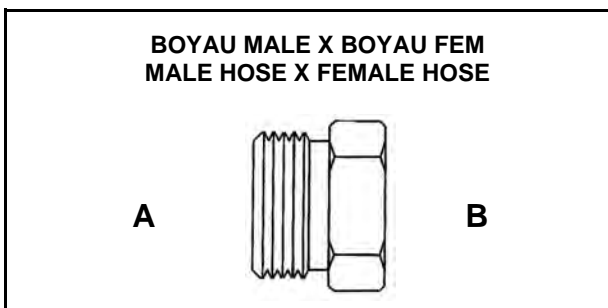

Code Vrac/Bulk	Sur carton Skin pack	Mod.	A	B
740-132	401-132	197-8-12	1/2	3/4
740-133	401-133	197-12-12	3/4	3/4

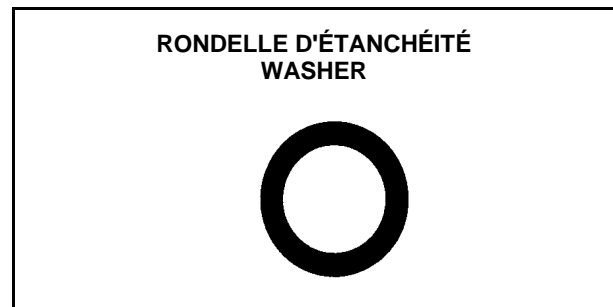

Code Vrac/Bulk	Sur carton Skin pack	Mod.	A
740-180	401-180	GHW-12	3/4



PITGAIL POL x 1/4 MPT		
Code	Mod.	Description
770-002	2001S-6	1/4 O.D. x 6"
770-012	2001S-12	1/4 O.D. x 12"
770-014	2001S-48	1/4 O.D. x 48"



POL X INVERTED FLARE		
Code	Mod.	Description
770-019	2010S-19	1/4 O.D. X 19"
770-021	2010S-30	1/4 O.D. X 30"
770-022	2010S-48	1/4 O.D. X 48"



PITGAIL 90° POL x 1/4 MPT		
Code	Mod.	Description
770-001	2001S-6	1/4 O.D. x 6"



HOGTAIL POL x POL		
Code	Mod.	Description
770-023	2009-12	3/8 O.D. x 12"
770-025	2009-36	3/8 O.D. x 36"
770-027	2009-48	3/8 O.D. x 48"



PIGTAIL POL x POL		
Code	Mod.	Description
770-015	2003S-19	1/4 O.D. x 19"
770-016	2003S-24	1/4 O.D. x 24"
770-017	2003S-30	1/4 O.D. x 30"
770-018	2003s-48	1/4 O.D. x 48"

OUTIL POUR ÉVASER
FLARING TOOL



Code	Grandeur / Size
749-112	3/16" O.D. - 3/4" O.D.

PINCE POUR COLLIERS DE SERRAGE
HAND PINCER FOR O-CLAMPS

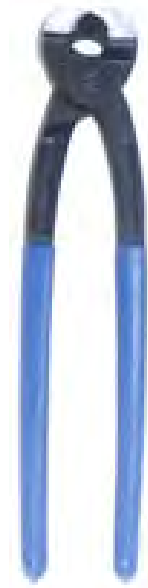

Code	Description
780-073	Pince à Main / hand pincer

MANOMÈTRE - MANOMETER



8"-0-8"

Code	Modèle Model	Description
748-493	MI-231	Lecture jusqu'à 16" Readings to 16"

VÉRIFICATEUR DE BASSE PRESSION
LOW PRESSURE GAS TEST KIT



Code	Modèle Model	Description
780-005	LPTK	Pour propane ou naturel For propane or natural
748-742		Adaptateur seulement Universal adapter only

**PÂTE À SCELLER - SEALING COMPOUND
SANS PLOMB - LEAD FREE**

- Composé pour joints de tuyauterie.
- Pour réfrigération, butane, eau, vapeur, essence, huile, gaz naturel et propane.
- Approuvé UL aux États Unis et Canada.
- La température du scellant: jusqu'à 400° F (204° C)
- Pression: de 5000 PSI (340 BAR pour le liquide et de 2,600 PSI (177 BAR) pour le gaz.
- *Soft set pipe thread compound.*
- *For refrigerants, butane, gasoline, oil, water, steam, air, natural and LP gas.*
- *Certified by UL in USA & Canada.*
- *Sealing temperature: up to 400° FA (204° C).*
- *Pressures: to 5,000 PSI (340 BAR) for liquids to 2,600 PSI (177 BAR) for gases.*



Code	Modèle Model	Format
780-077	CP-3	236 ml avec pinceau with brush
780-076	CP-3	473 ml avec pinceau With brush

**MASTIC À FILETAGES EN BATON
PIPE JOINT STICK COMPOUND**



- Étanchéité rapide et complète
- Pour eau, vapeur, gaz naturel, propane et butane
- *Positive quick seal*
- *For water, steam, air, natural, propane & butane gases.*

Code	Description
780-078	À l'unité / one piece

**RUBAN JAUNE SCELLANT
YELLOW GAS-TAPE**



Code	Description
780-012	La-Co Slic-Tite 1/2" x 260"
780-013	Ruban Jaune / Gas Tape Approuvé (CSA, UL) Approved 1/2" x 540"

**PÂTE AVEC TEFLON
PASTE WITH TEFLON**



Composé d'Étanchéité Robuste

- Pour raccords filetés sur l'acier, l'aluminium, le laiton, le PVC, le PVCC et l'ABS.
- Pression maximales: 10,000 psi pour les liquides et 3,000 psi pour les gaz.
- Températures -45° C to + 260° C.

Heavy-Duty Thread Compound

- *For threaded connections on steel, aluminum, brass, PVC, CPVC & ABS*
- *Working pressures: 10,000 psi liquids, 3,000 psi for gases.*
- *Temperatures -45° C to + 260° C.*



Code	Description
780-079	MT2 Tube 1-1/2 oz.

**DÉTECTEUR DE
FUITE *LEAK*
*DETECTOR***

- Fluorescent
- Toutes températures
- Sécuritaire pour l'oxygène

- *Fluorescent*
- *All Temperatures*
- *Safe for Oxygen Use*



Code	Modèle Model	Format
780-007	LD-1	16 oz.

**NETTOYANT POUR ACIER INOXYDABLE
*STAINLESS STEEL CLEANER***

DUSTBANE

- Poli et nettoyant
- Polish and cleaner

- ✓ Barbecues
- ✓ Cuisinières
- ✓ Restauration

- ✓ *Barbecue grills*
- ✓ *Ovens*
- ✓ *Restaurants*



Code	Description
665-010	Bouteille 397 G <i>397 G Bottle</i>